



US00D739222S

(12) **United States Design Patent**  
**Chadbourne**

(10) **Patent No.:** **US D739,222 S**

(45) **Date of Patent:** **\*\* Sep. 22, 2015**

(54) **TWO-PIECE MAGNETIC CLAMP**

**DESCRIPTION**

(71) Applicant: **Jeff Chadbourne**, Sacramento, CA (US)

(72) Inventor: **Jeff Chadbourne**, Sacramento, CA (US)

(\*\*) Term: **14 Years**

(21) Appl. No.: **29/472,493**

(22) Filed: **Nov. 13, 2013**

(51) **LOC (10) Cl.** ..... **08-08**

(52) **U.S. Cl.**  
USPC ..... **D8/394**

(58) **Field of Classification Search**

USPC ..... D8/72, 394-396, 499; D14/217, 223,  
D14/224, 433; D13/133; D11/87, 218;  
D23/260; 24/163 R, 196, 616, 303,  
24/115 R, 115 M, 712.9; 40/316, 661.01,  
40/661.05, 662

CPC ..... H01B 7/368; G09F 7/04; G09F 3/00;  
G09F 3/14; A44B 11/24; A44B 11/10; A44C  
5/2047; A44D 2203/00; A43C 7/00

See application file for complete search history.

FIG. 1 is a perspective view of a first embodiment of a two-piece magnetic clamp, showing my new design;

FIG. 2 is a top plan view thereof;

FIG. 3 is a side elevation view thereof;

FIG. 4 is a perspective view of the female half thereof;

FIG. 5 is a top plan view of the female half thereof;

FIG. 6 is a bottom plan view of the female half thereof;

FIG. 7 is a side elevation view of the female half thereof;

FIG. 8 is a perspective view of a male half thereof;

FIG. 9 is a top plan view of a male half thereof;

FIG. 10 is a bottom plan view of a male half thereof;

FIG. 11 is a side elevation view of a male half thereof;

FIG. 12 is a perspective view of a second embodiment;

FIG. 13 is a top plan view of a female half thereof;

FIG. 14 is a bottom plan view of a female half thereof;

FIG. 15 is a side elevation view of a female half thereof;

FIG. 16 is a perspective view of a male half thereof;

FIG. 17 is a top plan view of a male half thereof;

FIG. 18 is a bottom plan view of a male half thereof;

FIG. 19 is a front elevation view of a male half thereof;

FIG. 20 is a side elevation view of a male half thereof;

FIG. 21 is a perspective view of a third embodiment;

FIG. 22 is a top plan view of a female half thereof;

FIG. 23 is a bottom plan view of a female half thereof;

FIG. 24 is a side elevation view of a female half thereof;

FIG. 25 is a perspective view of a male half thereof;

FIG. 26 is a top plan view of a male half thereof;

FIG. 27 is a bottom plan view of a male half thereof;

FIG. 28 is a front elevation view of a male half thereof; and,

FIG. 29 is a side elevation view of a male half thereof.

The broken lines depict environment that forms no part of the claimed design.

(56) **References Cited**

**U.S. PATENT DOCUMENTS**

D309,094 S \* 7/1990 Donis et al. .... D8/354  
D356,520 S \* 3/1995 Bartky ..... D11/87

(Continued)

*Primary Examiner* — John Windmuller

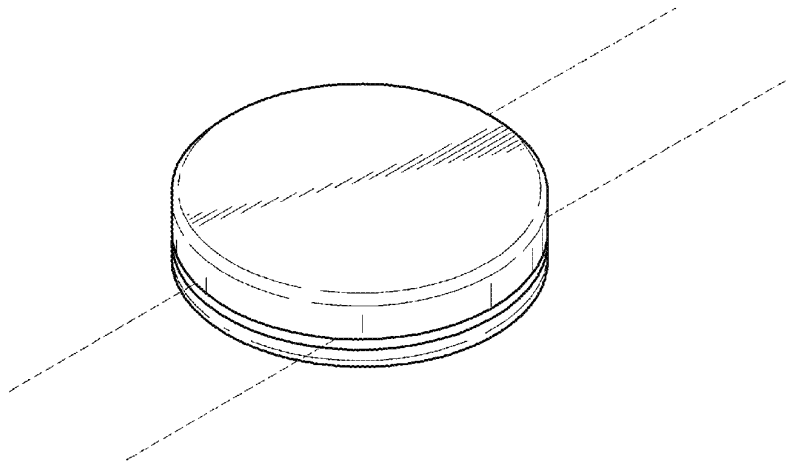
*Assistant Examiner* — Steven Cxyz

(74) *Attorney, Agent, or Firm* — Craig A. Simmermon

(57) **CLAIM**

The ornamental design for a two-piece magnetic clamp, as shown and described.

**1 Claim, 7 Drawing Sheets**



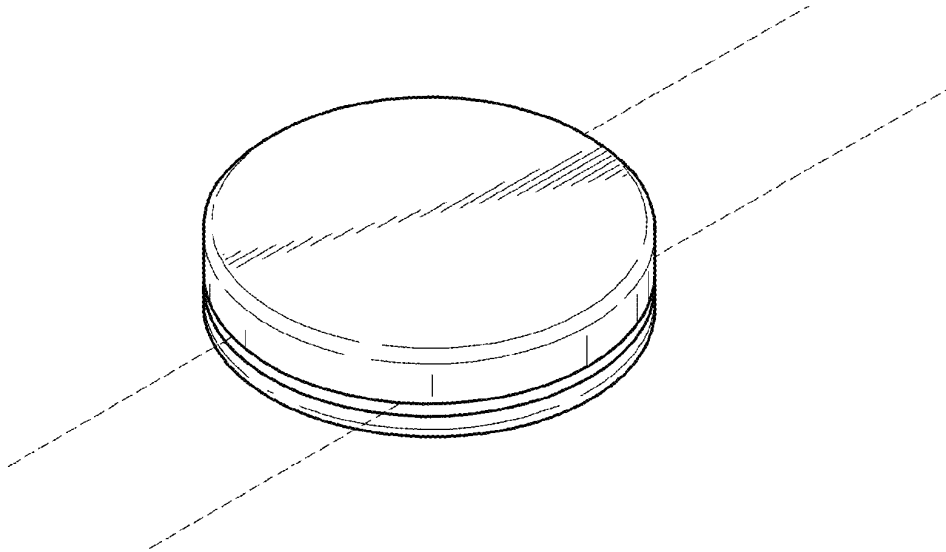
(56)

**References Cited**

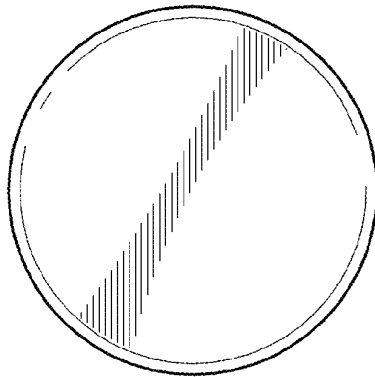
U.S. PATENT DOCUMENTS

D402,538	S *	12/1998	Wagter et al.	.....	D8/358
D424,924	S *	5/2000	Ackerman	.....	D8/396
D433,649	S *	11/2000	Buettell	.....	D11/200
D477,776	S *	7/2003	Pontaoe	.....	D8/396
D526,278	S *	8/2006	Heary, Sr.	.....	D13/154
D585,432	S *	1/2009	Baker	.....	D14/223
D585,433	S *	1/2009	Baker	.....	D14/223
D589,328	S *	3/2009	Edge	.....	D8/356
D599,478	S *	9/2009	Bizup et al.	.....	D24/128
D607,313	S *	1/2010	Larocque	.....	D8/394
D610,549	S *	2/2010	Baker	.....	D13/154
7,654,484	B2 *	2/2010	Mogensen et al.	.....	242/402
D616,032	S *	5/2010	Maraia	.....	D20/28
7,854,750	B2 *	12/2010	Bonutti et al.	.....	606/232
D631,730	S *	2/2011	Skillman	.....	D8/356
D631,780	S *	2/2011	Levy	.....	D11/87
D647,496	S *	10/2011	Tung	.....	D13/183
D658,094	S *	4/2012	Dunn	.....	D11/184
D670,995	S *	11/2012	Stieler	.....	D8/356
8,955,356	B1 *	2/2015	Smith	.....	63/40
2005/0278903	A1 *	12/2005	Dunaye	.....	24/303
2015/0113843	A1 *	4/2015	Berry	.....	40/600

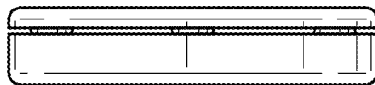
\* cited by examiner



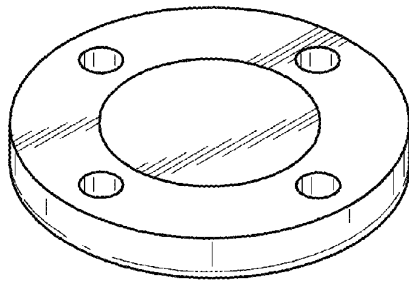
**FIG. 1**



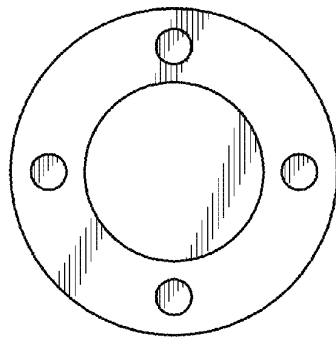
**FIG. 2**



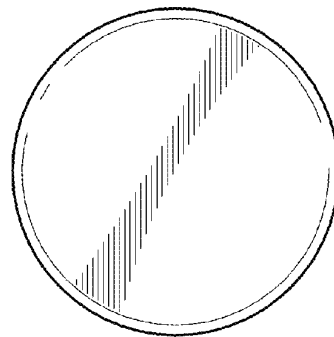
**FIG. 3**



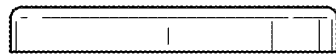
**FIG. 4**



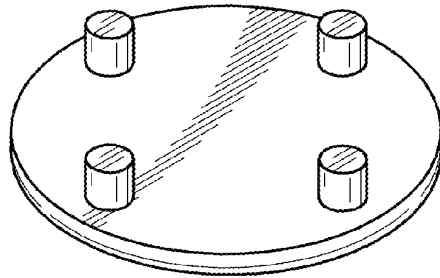
**FIG. 5**



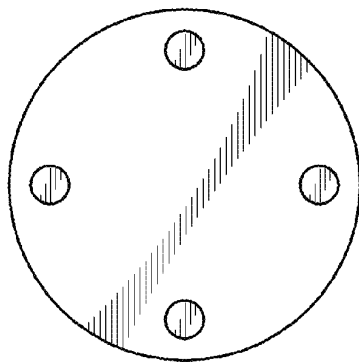
**FIG. 6**



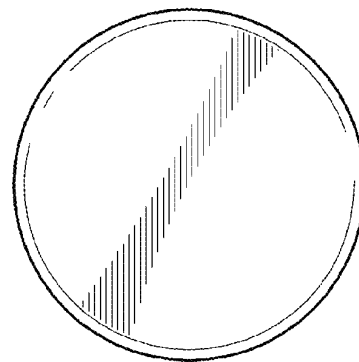
**FIG. 7**



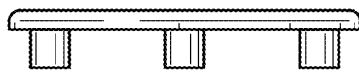
**FIG. 8**



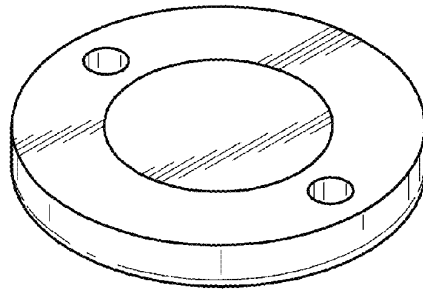
**FIG. 9**



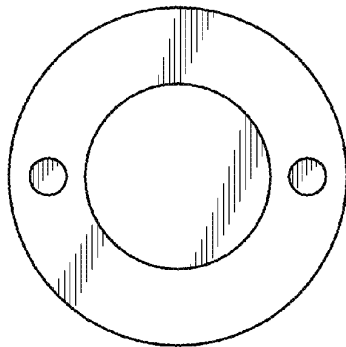
**FIG. 10**



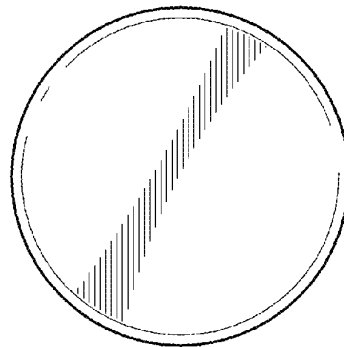
**FIG. 11**



**FIG. 12**



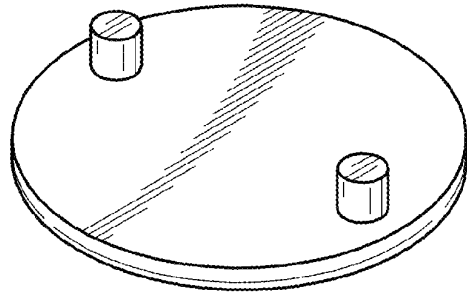
**FIG. 13**



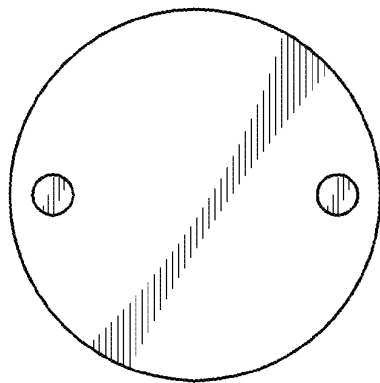
**FIG. 14**



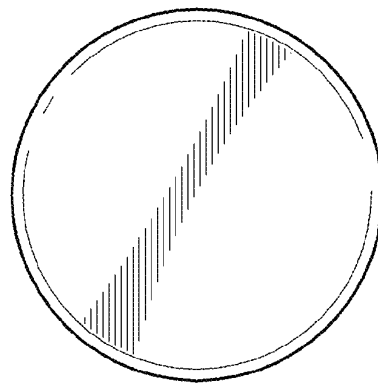
**FIG. 15**



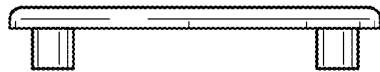
**FIG. 16**



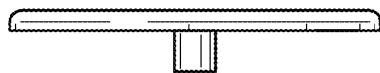
**FIG. 17**



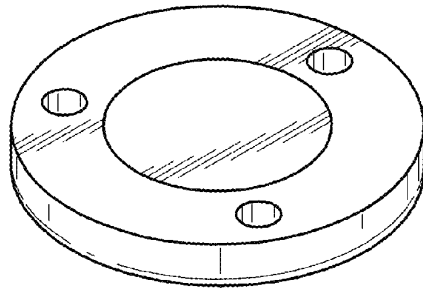
**FIG. 18**



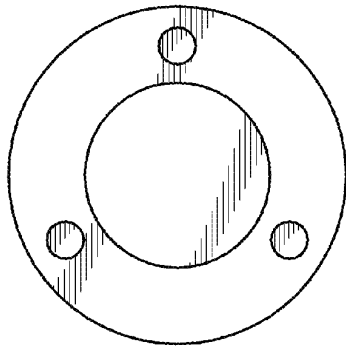
**FIG. 19**



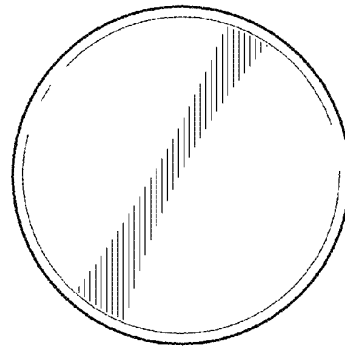
**FIG. 20**



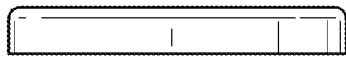
**FIG. 21**



**FIG. 22**

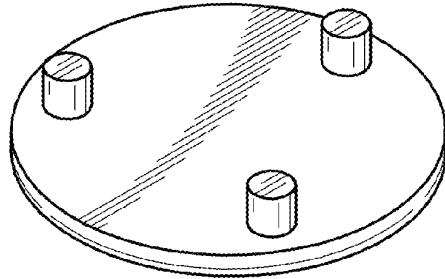


**FIG. 23**

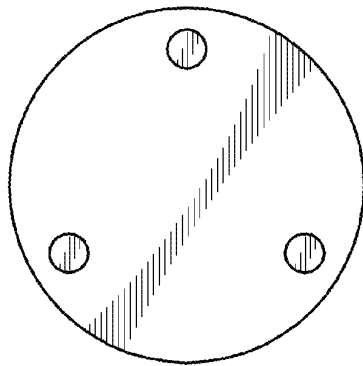


**FIG. 24**

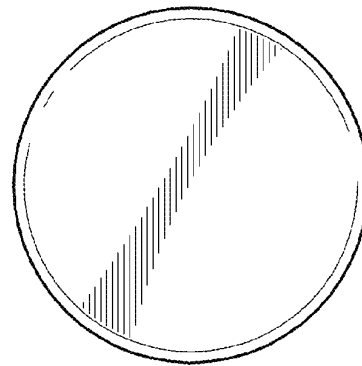




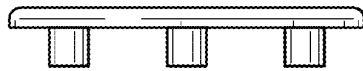
**FIG. 25**



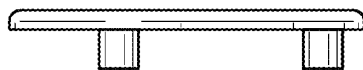
**FIG. 26**



**FIG. 27**



**FIG. 28**



**FIG. 29**