



US0D1119160S

(12) **United States Design Patent**  
**Vanderklay**

(10) **Patent No.:** **US D1,119,160 S**

(45) **Date of Patent:** **\*\* Mar. 17, 2026**

(54) **TWO-PIECE COIN BOX**

(74) *Attorney, Agent, or Firm* — Craig A. Simmermon

(71) Applicant: **Jared W Vanderklay**, Sacramento, CA (US)

(57) **CLAIM**

The ornamental design for a two-piece coin box, as shown and described.

(72) Inventor: **Jared W Vanderklay**, Sacramento, CA (US)

**DESCRIPTION**

(\*\*) Term: **15 Years**

FIG. 1 is a bottom perspective view of a two-piece coin box, showing my new design, with the upper portion shown separately for ease of illustration;

(21) Appl. No.: **29/983,901**

FIG. 2 is a front elevation view thereof;

(22) Filed: **Jan. 13, 2025**

FIG. 3 is a rear elevation view thereof;

(51) **LOC (15) Cl.** ..... **99-00**

FIG. 4 is a right side elevation view thereof;

(52) **U.S. Cl.**

FIG. 5 is a left side elevation view thereof;

USPC ..... **D99/34**

FIG. 6 is a top plan view thereof;

(58) **Field of Classification Search**

FIG. 7 is a bottom plan view thereof;

USPC ..... D99/28, 34, 35, 36, 43, 99; D18/46, 47, D18/3.1, 3.3, 12, 12.1; D3/201, 272, (Continued)

FIG. 8 is a top perspective view of a two-piece coin box, showing my new design, with the lower portion shown separately for ease of illustration;

(56) **References Cited**

**U.S. PATENT DOCUMENTS**

FIG. 9 is a front elevation view thereof;

363,239 A \* 5/1887 Howe ..... A45C 1/02 206/0.81

FIG. 10 is a rear elevation view thereof;

518,948 A \* 5/1894 Hayden ..... A45C 1/02 206/0.81

FIG. 11 is a right side elevation view thereof;

(Continued)

FIG. 12 is a left side elevation view thereof;

**FOREIGN PATENT DOCUMENTS**

DE 40009132 \* 1/2001  
KR 3019990028692 \* 2/2001

FIG. 13 is a top plan view thereof;

**OTHER PUBLICATIONS**

Whitman Plastic 2x2 Coin Storage Box Two Pack, <https://www.amazon.com/Whitman-Plastic-Coin-Storage-Pack/dp/B07HQWHBSY>, Mar. 22, 2019. (Year: 2019).\*

FIG. 14 is a bottom plan view thereof;

(Continued)

FIG. 15 is a top perspective view of a two-piece coin box showing my new design, with the upper and lower portions assembled;

FIG. 16 is a front elevation view thereof;

FIG. 17 is a rear elevation view thereof;

FIG. 18 is a right side elevation view thereof;

FIG. 19 is a left side elevation view thereof;

FIG. 20 is a top plan view thereof;

FIG. 21 is a bottom plan view thereof;

FIG. 22 is a cross-sectional view taken along lines 22-22 in FIG. 20; and,  
FIG. 23 is an exploded, top perspective view thereof, shown in a used condition with environmental subject matter shown in broken lines.

The broken lines depict unclaimed environmental subject matter that forms no part of the claimed design.

**1 Claim, 20 Drawing Sheets**

*Primary Examiner* — Elizabeth J Oswecki

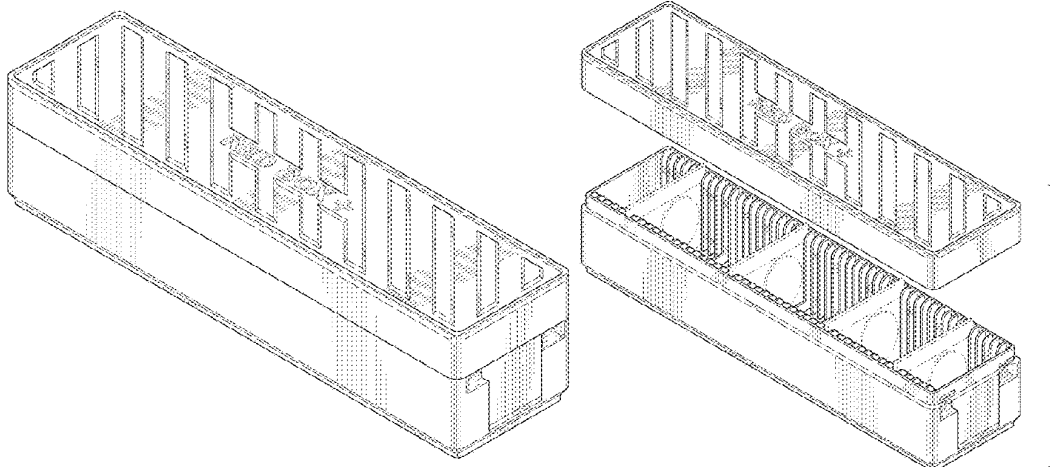

(58) **Field of Classification Search**

USPC ..... D3/273, 304, 318, 319, 901, 903, 904,  
 D3/905; D6/672, 675, 675.1, 675.3,  
 D6/675.4  
 CPC ..... A45C 1/10; A45C 1/12; A45C 2001/125;  
 A45C 2001/003; A45C 2001/006; A45C  
 2001/028; A45C 2001/102; A45C  
 2001/104; A45C 2001/105; A45C  
 2001/107; A45C 2001/108; G07D 9/00;  
 G07D 9/002; G07D 9/004; G07D 9/006;  
 G07D 9/008; G07D 9/02; G07D 9/04;  
 G07D 9/06; G07D 9/065; G07D 11/00;  
 G07D 13/00; G07F 9/00; G07F 9/06;  
 G07F 9/08; B42F 5/00; B42F 5/005;  
 B42F 5/02; B42F 5/04; A47F 5/00; A47F  
 5/0018; A47F 5/0025; A47F 7/283; A47F  
 7/28; A47F 3/14

See application file for complete search history.

4,479,502 A \* 10/1984 Iversen ..... G07D 1/08  
 211/75  
 D279,934 S \* 7/1985 Eriksson ..... D99/34  
 D286,938 S \* 11/1986 Povitz ..... D99/34  
 D315,648 S \* 3/1991 Castillo ..... D21/392  
 D335,751 S \* 5/1993 Johnson ..... D99/34  
 D388,234 S \* 12/1997 Joshua, II ..... D99/34  
 6,502,692 B1 \* 1/2003 Gentle ..... G07D 9/004  
 206/508  
 D526,760 S \* 8/2006 Fraser ..... D99/34  
 D648,095 S \* 11/2011 Fernandez ..... D99/34  
 D657,427 S \* 4/2012 Gelinotte ..... G07G 1/009  
 D21/392  
 D734,611 S \* 7/2015 Baruch ..... D3/313  
 D835,879 S \* 12/2018 Schaub ..... D99/34  
 D886,899 S \* 6/2020 Jung ..... D18/12.1  
 D898,347 S \* 10/2020 Lee ..... D3/203.3  
 D957,264 S \* 7/2022 Tan ..... D9/756  
 D1,085,623 S \* 7/2025 Posadas ..... D99/34  
 2015/0122754 A1 \* 5/2015 Jung ..... G07D 9/002  
 211/49.1

(56)

**References Cited**

U.S. PATENT DOCUMENTS

838,121 A \* 12/1906 Kollie et al. .... A47F 5/01  
 211/49.1  
 858,331 A \* 6/1907 Brewster ..... A45C 1/02  
 206/0.81  
 1,751,615 A \* 3/1930 Bower ..... G07D 9/06  
 206/0.83  
 D160,231 S \* 9/1950 Ward ..... D11/79  
 D160,988 S \* 11/1950 Ament ..... D99/36  
 2,553,081 A \* 5/1951 Cohen ..... A45C 1/02  
 453/54  
 2,597,365 A \* 5/1952 Newman ..... G07D 9/002  
 206/0.81  
 2,642,985 A \* 6/1953 Whitcomb ..... G07D 9/002  
 206/0.83  
 2,735,541 A \* 2/1956 Mosler ..... G07D 9/002  
 206/0.81  
 D188,511 S \* 8/1960 Shanok ..... D99/34  
 2,954,120 A \* 9/1960 Norcross ..... G07D 9/002  
 206/0.84  
 D189,215 S \* 11/1960 Henkel ..... D99/34  
 3,107,467 A \* 10/1963 Gates ..... G07D 9/002  
 294/51  
 3,127,009 A \* 3/1964 Feis et al. .... G07D 9/004  
 206/0.8  
 D198,990 S \* 8/1964 Lanier ..... D99/34  
 3,606,008 A \* 9/1971 Lusetti ..... G07D 9/004  
 206/0.84  
 4,049,115 A \* 9/1977 Pasbrig ..... A45C 1/00  
 206/0.84  
 D247,829 S \* 5/1978 Schnitzer ..... D99/34  
 D262,749 S \* 1/1982 Taivalvu ..... 446/8  
 D273,403 S \* 4/1984 DeLuca ..... D21/392

OTHER PUBLICATIONS

BCW Double Row 2x2 Coin Box | Holds 102 Snaps or 330+ Paper  
 Flips | Coin Storage Box for Collectors | Removable Trays, [Mudor 2 Pack Coin Slab Storage Box, Black Plastic Coin Holder  
 Case Compatible with 20 Slab PCCB PCGS, Olly Box, \[50 Coin Wood Display Box for NGC or PCGS Coins,\\[\\\\* cited by examiner\\]\\(https://www.currencyandcoin.com/50-coin-wood-display-box-for-ngc-or-pcgs-coins/,https://www.currencyandcoin.com/50-coin-wood-display-box-for-ngc-or-pcgs-coins/, 2016. \\(Year: 2016\\).\\*</a></p>
</div>
<div data-bbox=\\)\]\(https://www.amazon.com/dp/B0CVP44M92/ref=sspa\_dk\_detail\_1?psc=1&pf\_rd\_p=f2f1cf8f-cab4-44dc-82ba-0ca811fb90cc&pf\_rd\_r,Jan. 26, 2025. \(Year: 2025\).\*</a><br/>
    Certified Coin Wood Teak Finish Thirty-Coin Storage/Display Box<br/>
    for Certified or Certified Style Coin Holders PCGS/NGC/Premier/<br/>
    Ursae Minoris,<a href=\)](https://www.amazon.com/Double-Row-2x2-Coin-Box/dp/B07NDNVCY8/ref=pd_lpo_d_scc1_2/137-7100243-6267368?pd_rd_w=EGF71&content-id=amzn1.sym.4c8c52db,Jan. 29, 2024. (Year: 2024).*</a><br/>
    NGC Plastic Storage Box for 20 Slab Coin Holders,<a href=)

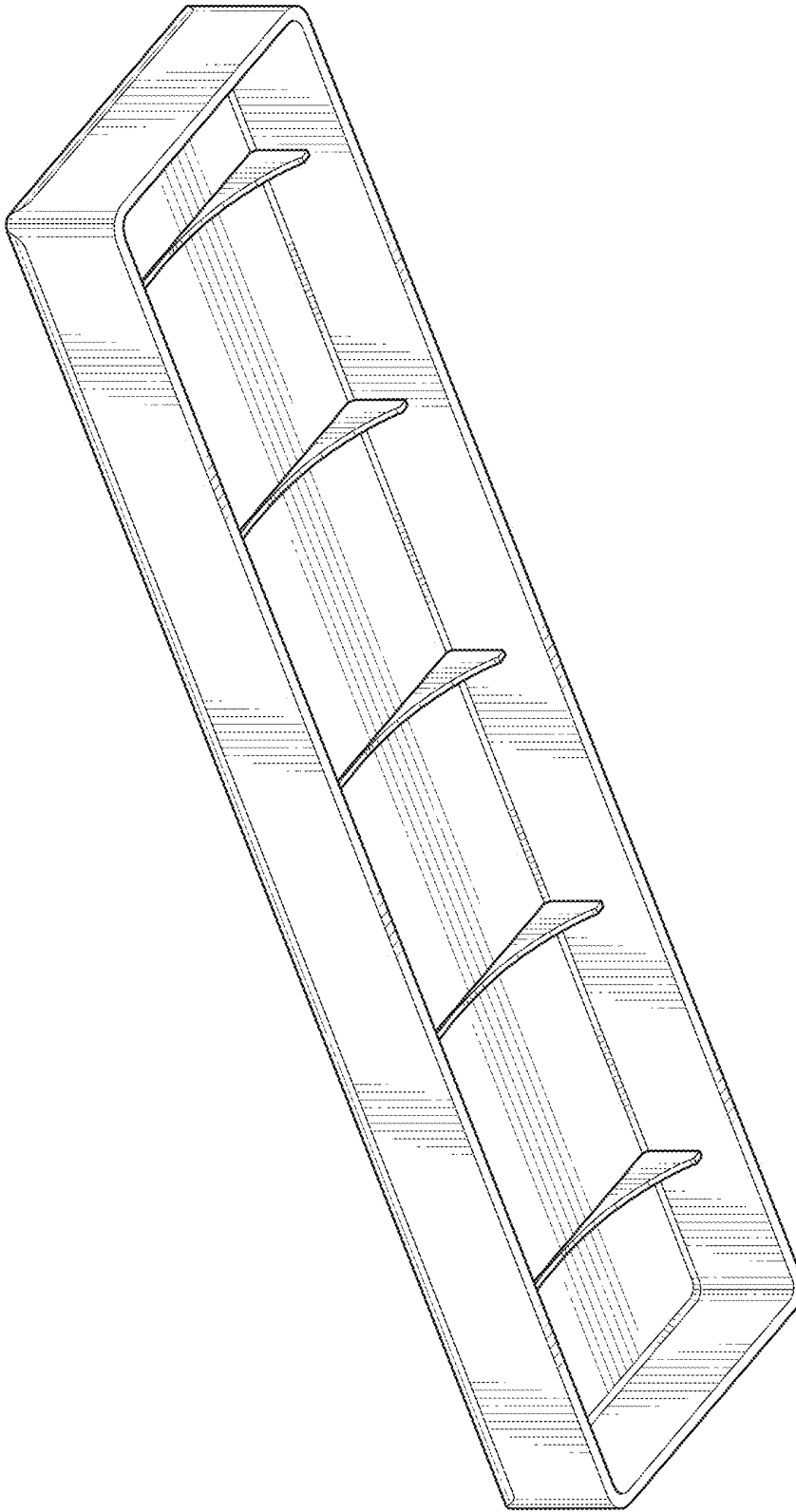

FIG. 1

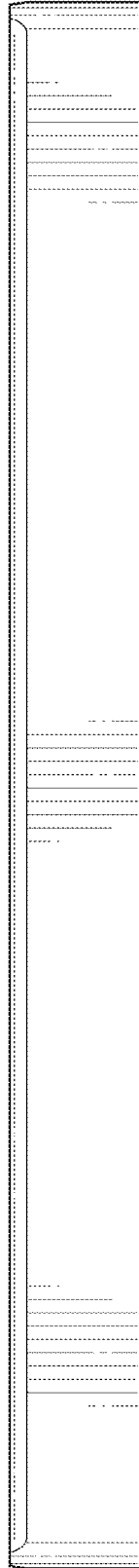

FIG. 2

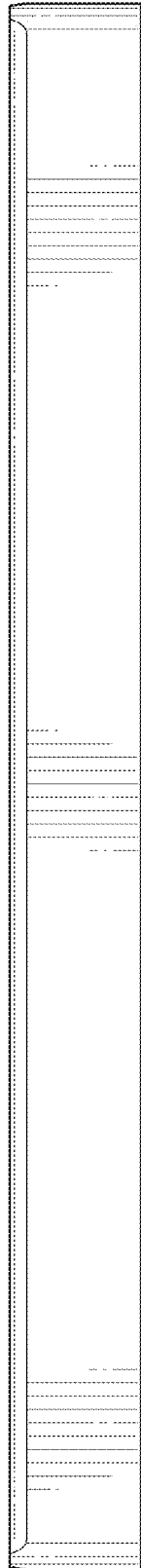

FIG. 3

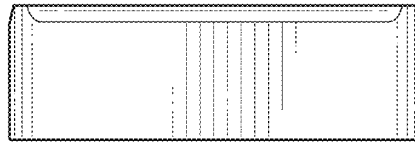

FIG. 4

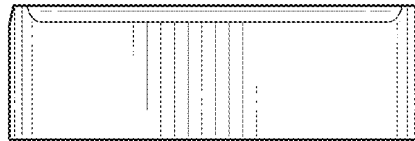

FIG. 5

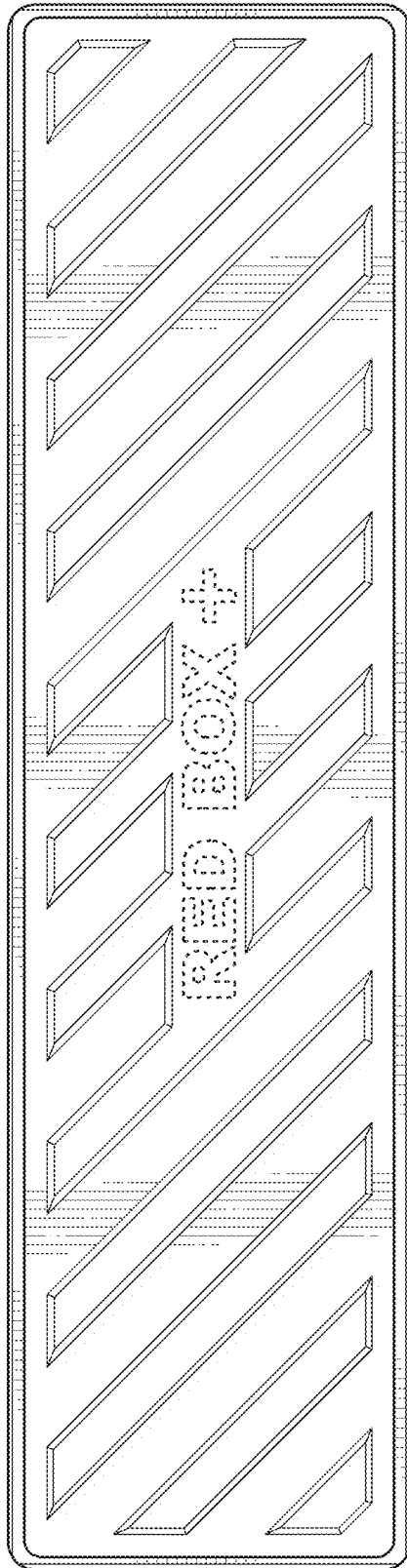

FIG. 6

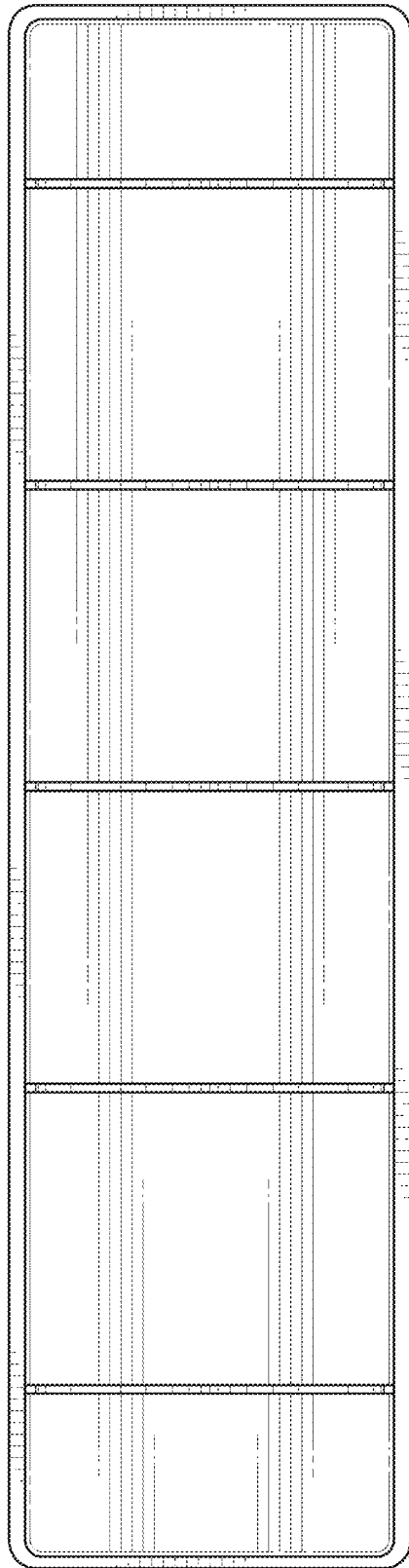

FIG. 7

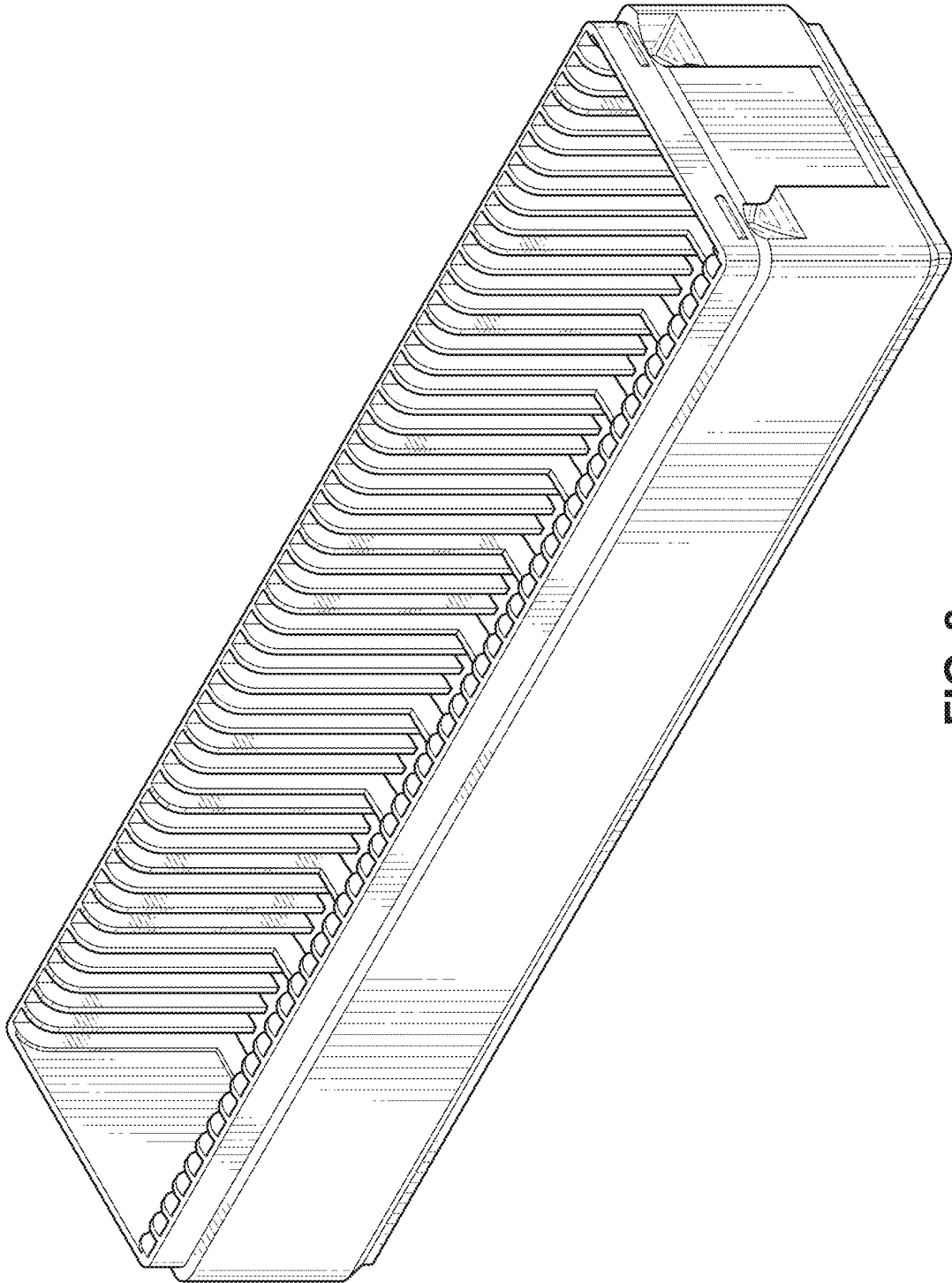

FIG. 8

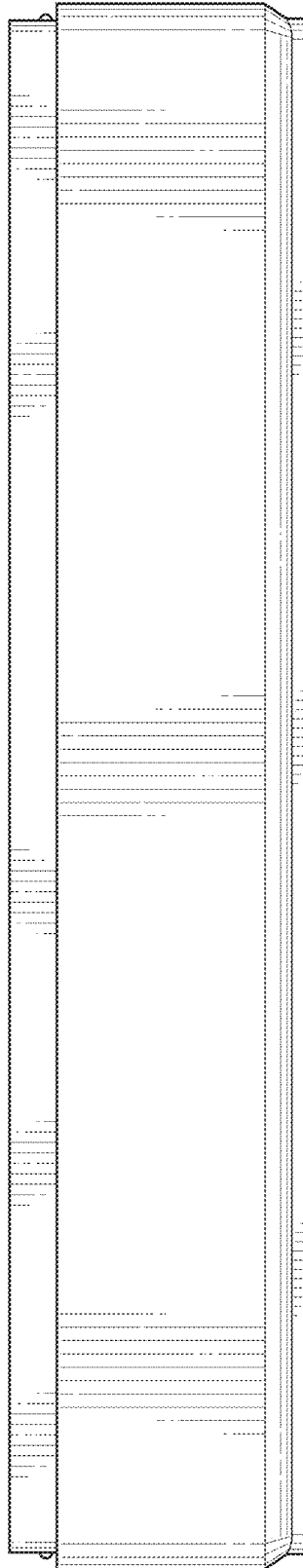

FIG. 9

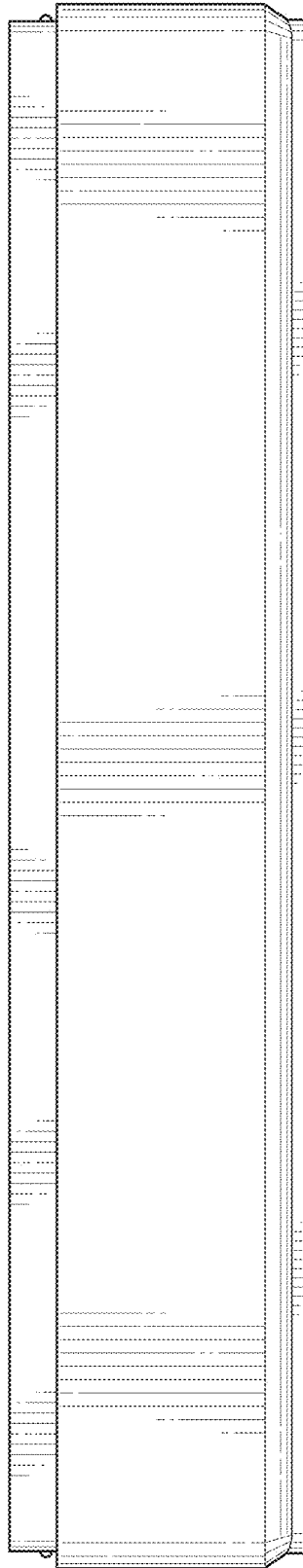

FIG. 10

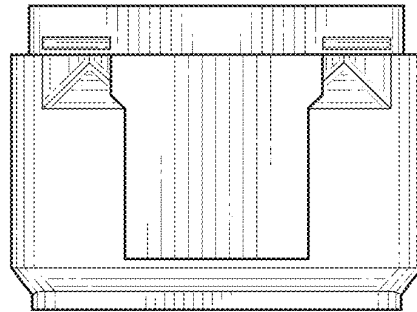

FIG. 11

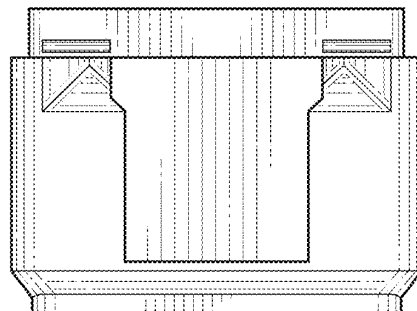

FIG. 12

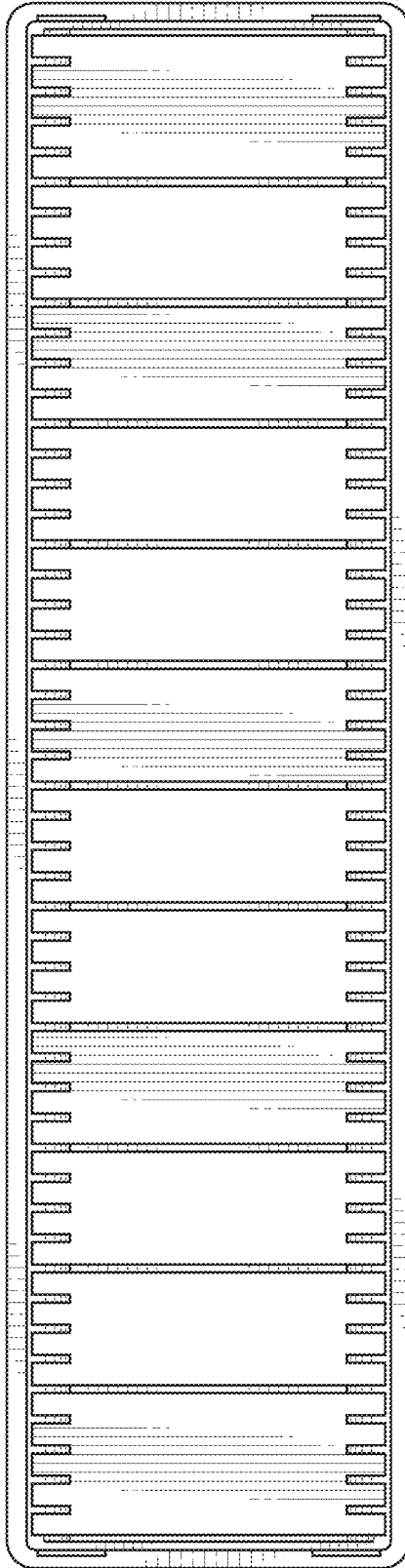

FIG. 13

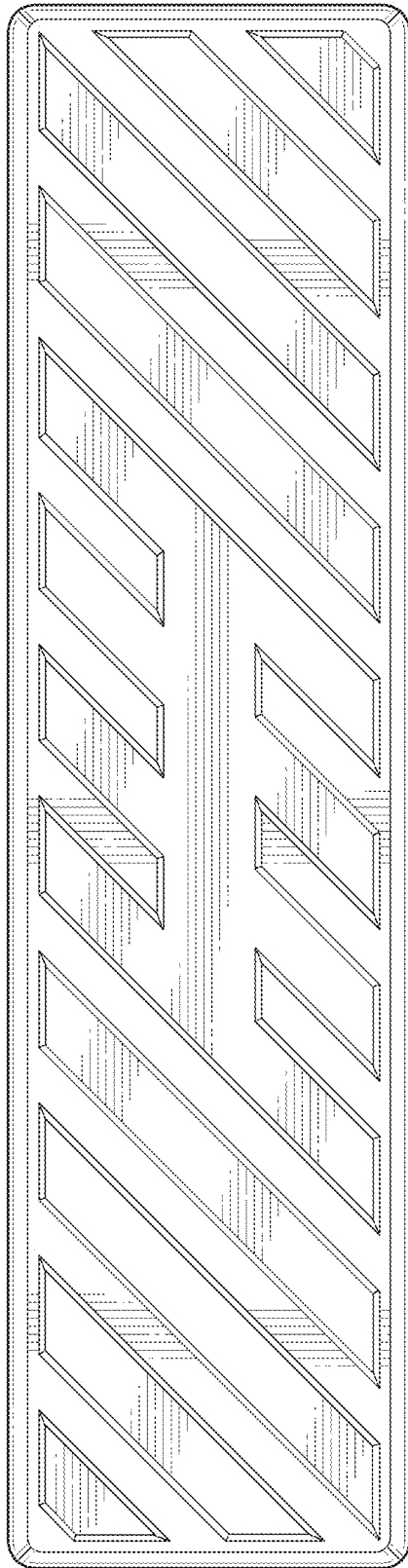

FIG. 14

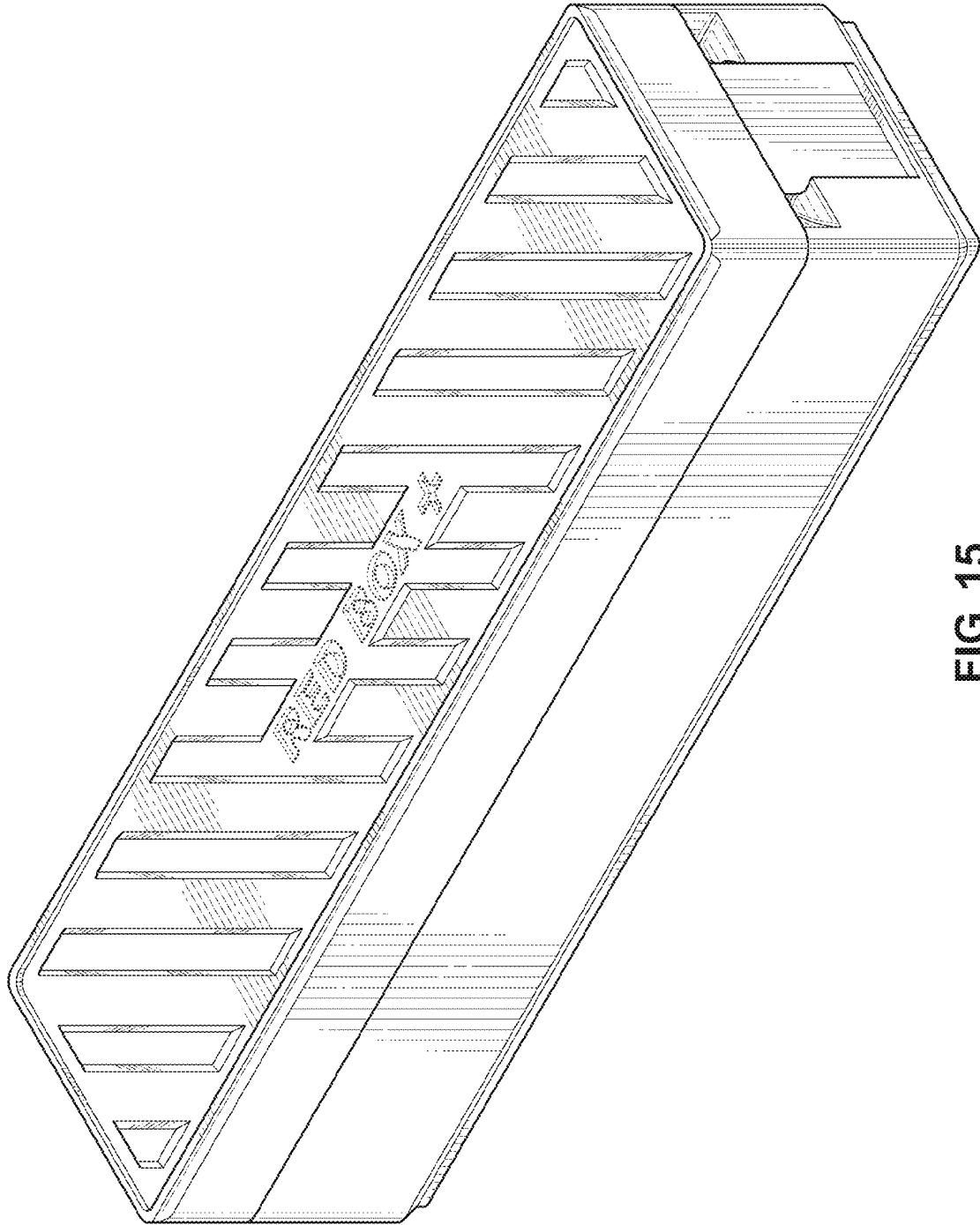

FIG. 15

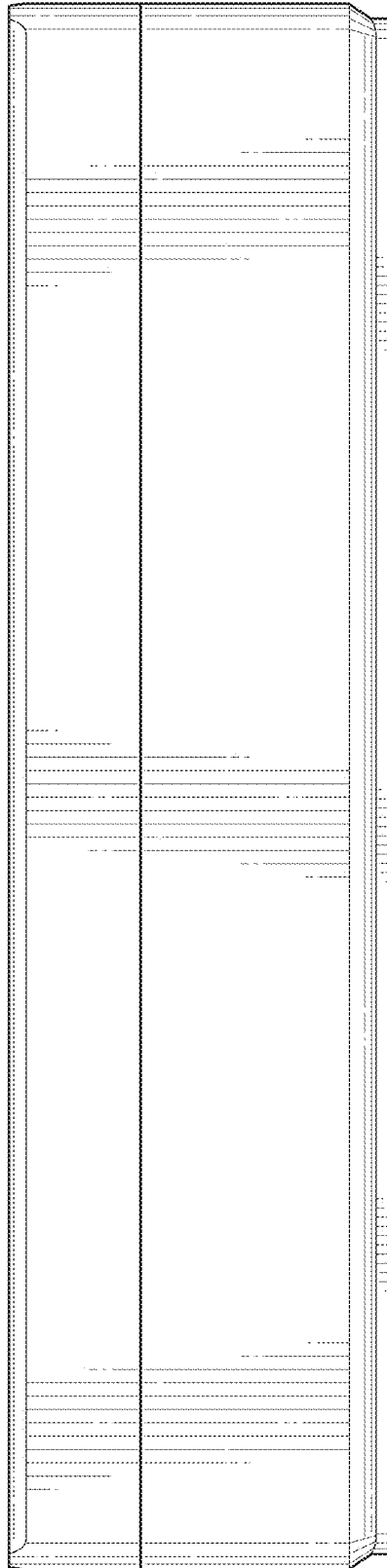

FIG. 16

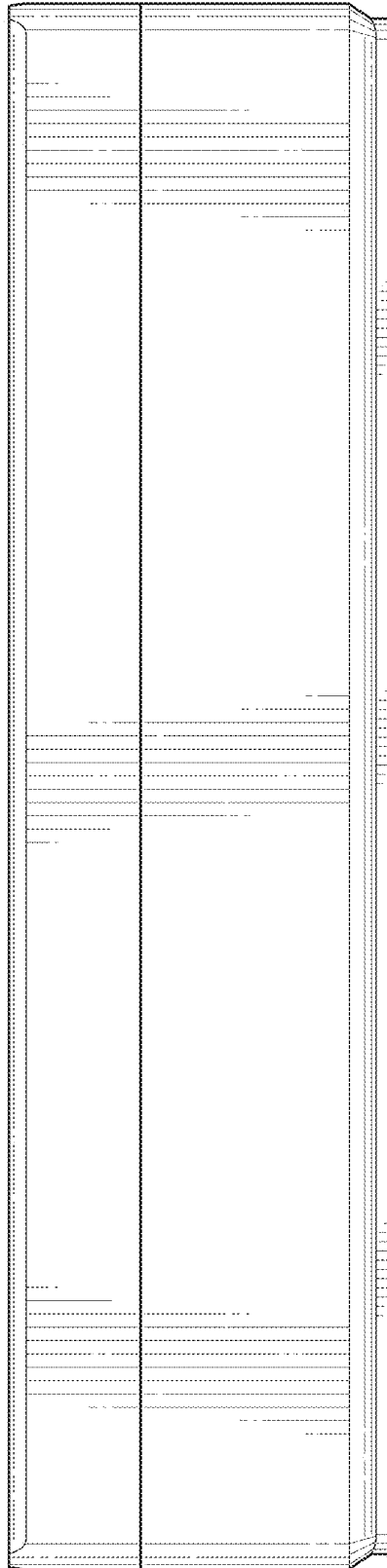

FIG. 17

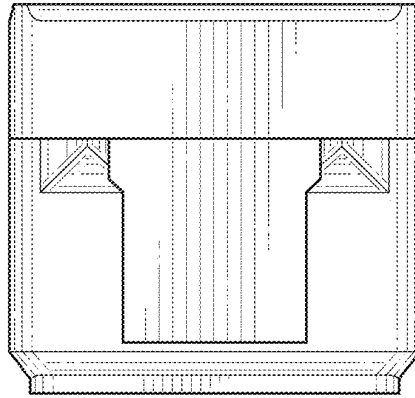

FIG. 18

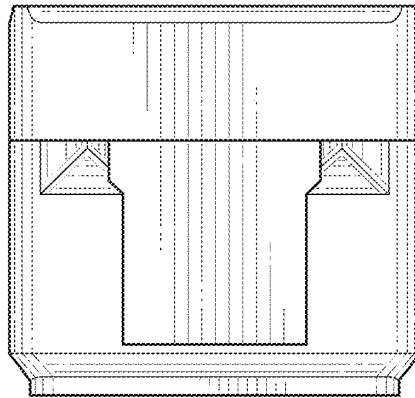

FIG. 19

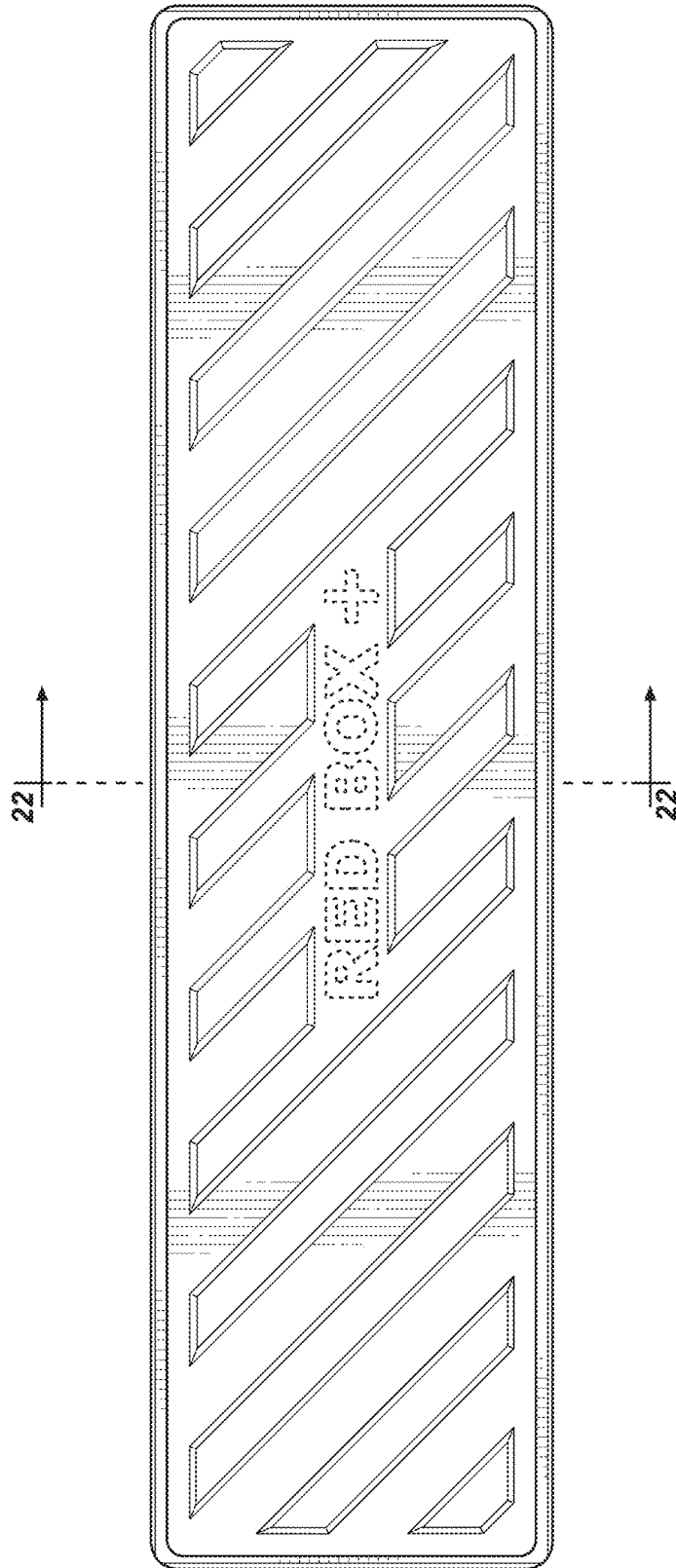

FIG. 20

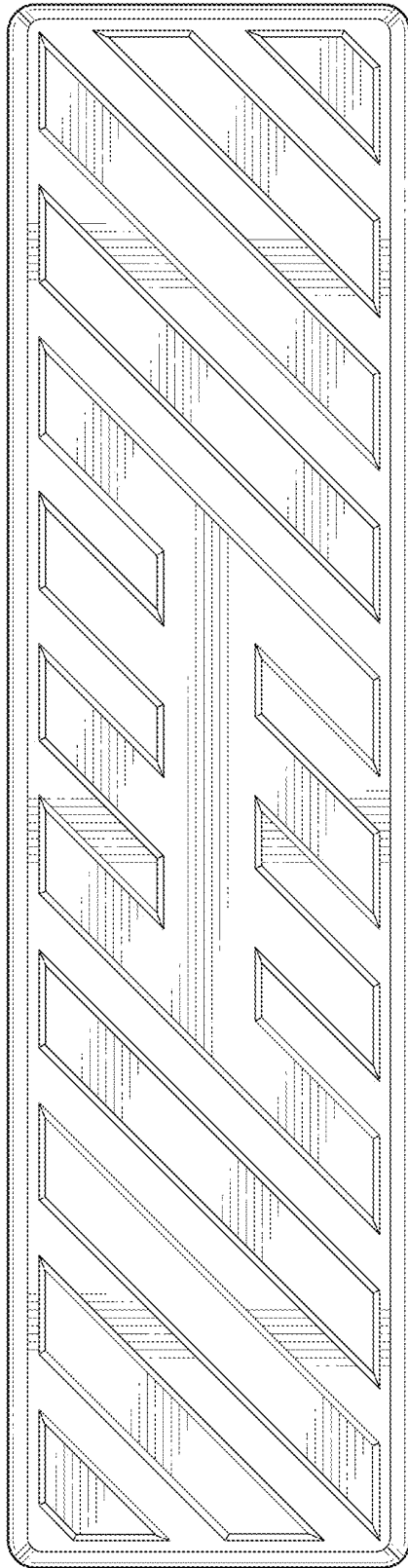

FIG. 21

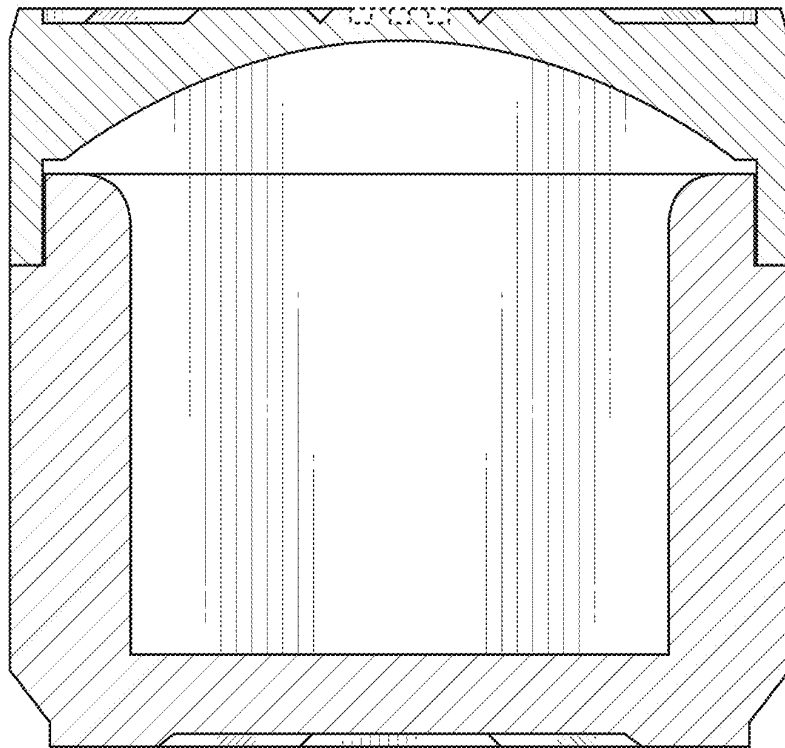

FIG. 22

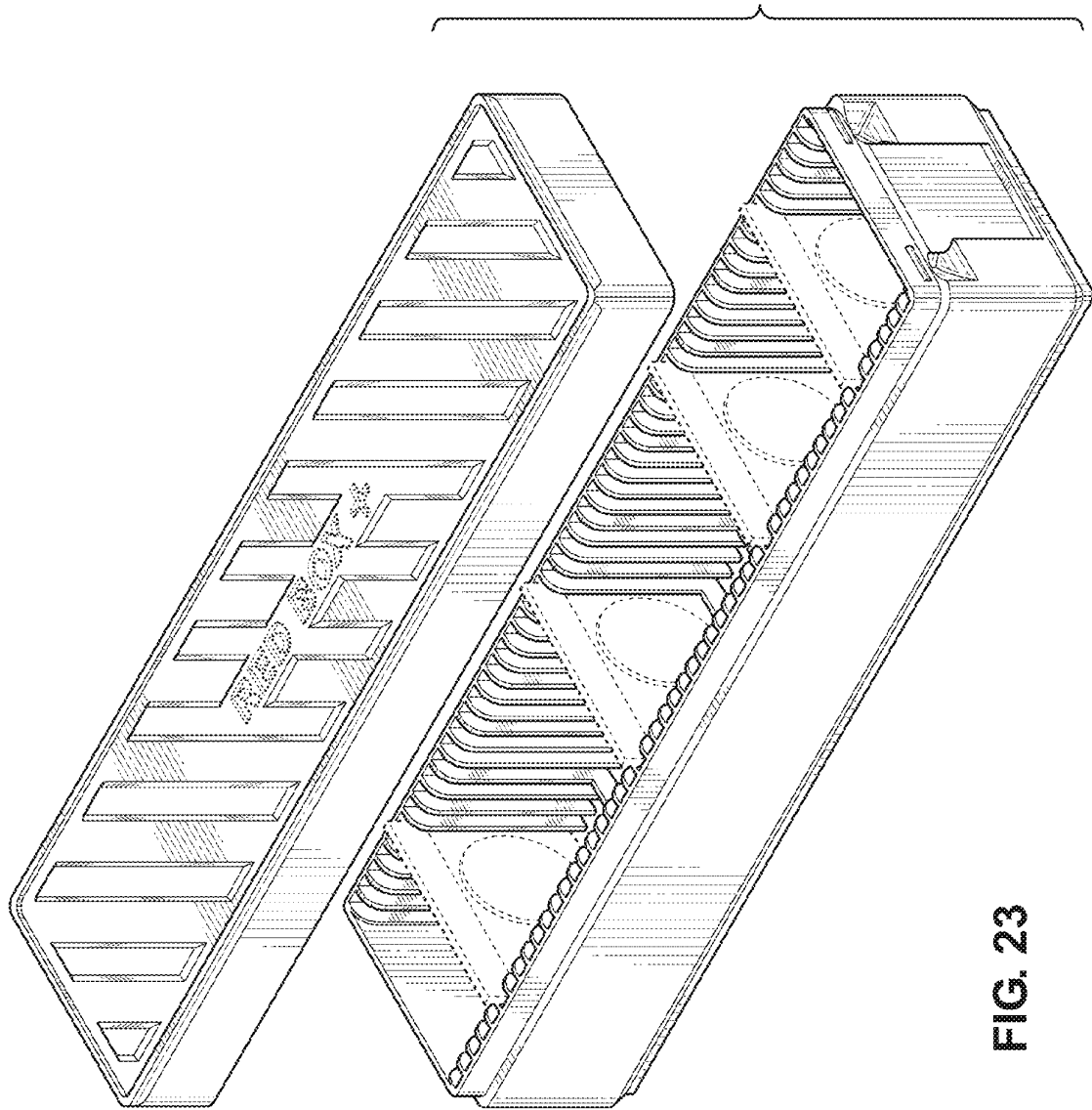

FIG. 23